

14.2 Dimensioni serie FP
 Dimensions FP series
 Abmessungen Serie FP

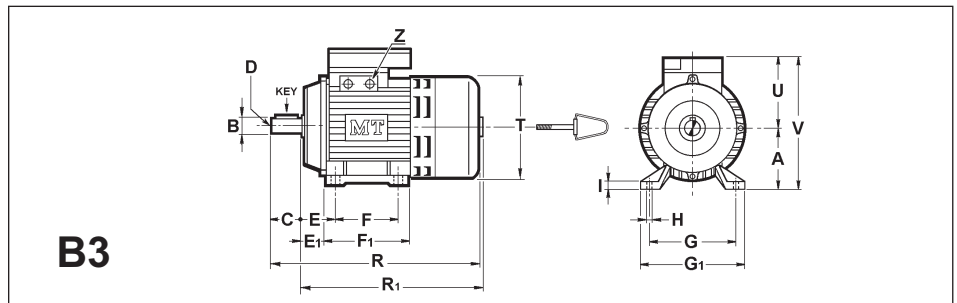
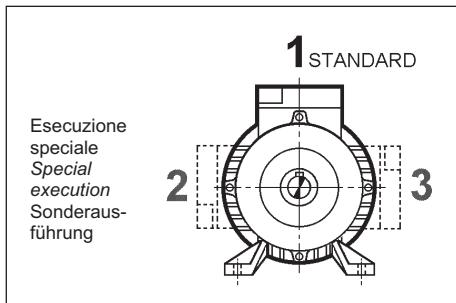
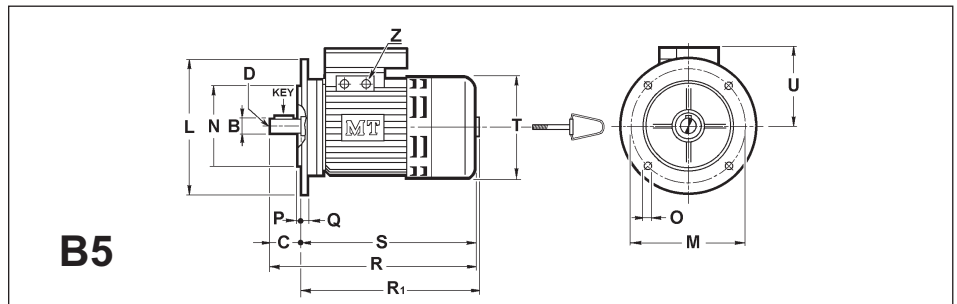
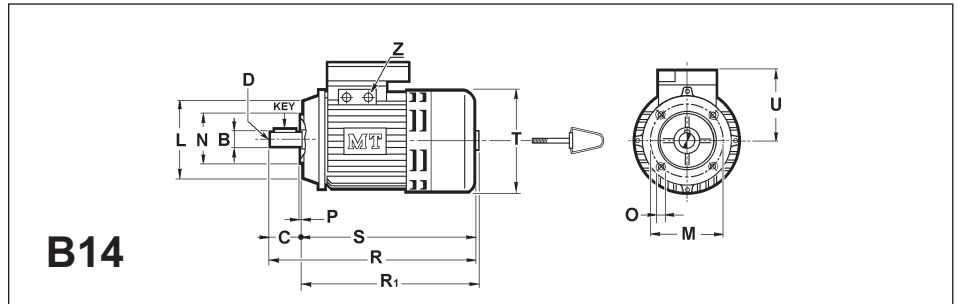
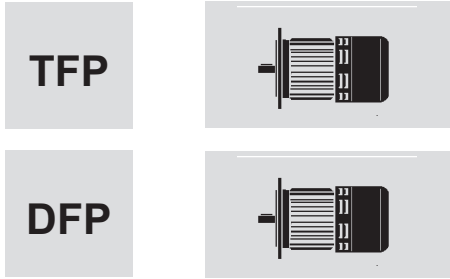

	B3										B14					
	A	E	E1	F	F1	G	G1	H	I	V	L	M	N	O	P	S
63	63	40	28	80	105	100	120	7	10	168	90	75	60	M5	2.5	280
71	71	45	36	90	108	112	136	7	11	185	105	85	70	M6	2.5	302
80	80	50	38	100	125	125	154	9.5	11	206	120	100	80	M6	3	336
90 S	90	56	41	100	130	140	174	9.5	13	223	140	115	95	M8	3	321
90 L	90	56	41	125	155	140	174	9.5	13	223	140	115	95	M8	3	390
100	100	63	46	140	175	160	192	12	14	242	160	130	110	M8	3.5	415
112	112	70	53	140	180	190	234	12	14	265	160	130	110	M8	3.5	455
132 S	132	89	60	140	180	216	256	12	16	310	200	165	130	M10	4	532
132 M	132	89	60	178	218	216	256	12	16	310	200	165	130	M10	4	570
160 M	160	108	82	210	260	254	310	15	22	400	250	215	180	M10	4	668
160 L	160	108	82	254	320	254	330	15	22	400	250	215	180	M10	4	712
180	180	121	96	279	329	279	359	13	25	436	—	—	—	—	—	—
200	200	133	108	305	355	318	398	20.5	25	456	—	—	—	—	—	—

	B3 - B5 -B14										B5					
	B	C	D	R	R1	T	U	Z	Key	L	M	N	O	P	Q	S
63	11	23	M4	303	288	124	105	M16x1.5	4x4x15	140	115	95	9	3	9	280
71	14	30	M5	332	308	140	114	M20x1.5	5x5x20	160	130	110	9	3.5	9	302
80	19	40	M6	376	342	158	126	M20x1.5	6x6x30	200	165	130	11	3.5	10	336
90 S	24	50	M8	415	371	178	133	M20x1.5	8x7x40	200	165	130	11	3.5	10	321
90 L	24	50	M8	440	396	178	133	M20x1.5	8x7x40	200	165	130	11	3.5	10	390
100	28	60	M10	475	421	198	142	M20x1.5	8x7x40	250	215	180	14	4	14	415
112	28	60	M10	515	461	222	153	M20x1.5	8x7x40	250	215	180	14	4	14	455
132 S	38	80	M12	612	538	255	178	M32x1.5	10x8x70	300	265	230	14	4	20	532
132 M	38	80	M12	650	576	255	178	M32x1.5	10x8x70	300	265	230	14	4	20	570
160 M	42	110	M16	778	674	317	340	M32x1.5	12x8x90	350	300	250	19	5	16	668
160 L	42	110	M16	822	718	317	340	M32x1.5	12x8x90	350	300	250	19	5	16	712
180	48	110	M16	940	935	360	256	M32x1.5	14x8	350	300	250	19	5	20	830
200	55	110	M20	955	850	360	256	M32x1.5	16x10	400	350	300	19	5	20	845